



# PAN

ombrellone con molla a gas | parasol with gas spring  
Sonnenschirm mit Gasfeder

## IT

- struttura in alluminio verniciato opaco
- componenti in nylon e acciaio verniciato
- bulloneria in acciaio inox
- stecche in alluminio verniciato opaco
- apertura con maniglia agevolata da molla a gas
- chiusura retrattile
- tessuto acrilico tinto in massa e bordo
- camino antivento con telaio in alluminio

## DE

- Gestell aus matt lackiertem Aluminium
- Nylonbestandteile und lackierte Stahlbestandteile
- Edelstahlbolzen
- Streben aus matt lackiertem Aluminium
- Öffnung mit Hebel durch Gasfedersystem
- Einziehbare Verschluss
- Stoff und Saum aus düsengefärbter Acrylfaser
- Windkamin mit Alu-Struktur

## EN

- frame of matt varnished aluminium
- nylon and varnished steel components
- nuts and bolts of stainless steel
- ribs of matt varnished aluminium
- handle opening through gas spring system
- retractable closing
- solution dyed acrylic fabric and border
- wind-proof chimney with aluminium frame



## bases

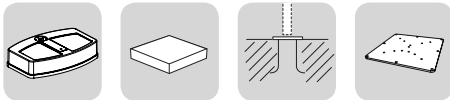

## details



## accessories

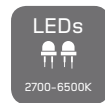

## location



## colours

telaio nei colori bianco, antracite, corten o RAL a scelta  
frame available in white, anthracite, corten or optional RAL  
Gestellfarben: Weiß, Antrazit, Corten oder RAL-Farben nach Wahl



sistema di apertura e chiusura  
opening and closing system  
Öffnung und Schließung System

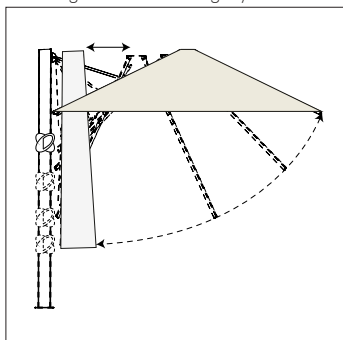

rotazione 360° con 12 posizioni  
360 degree rotation with 12 positions  
360° drehbar mit 12 Positionen

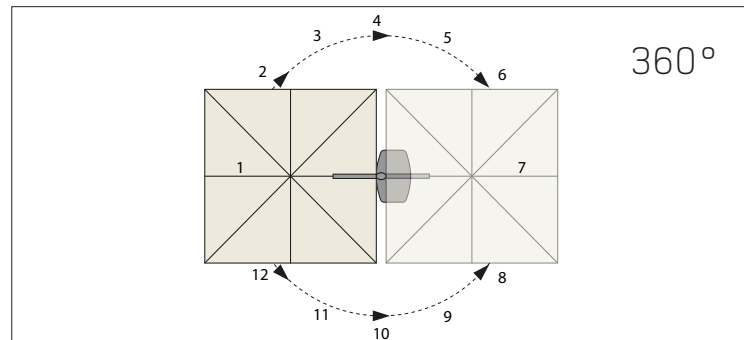

batteria al litio con carica batteria  
lithium battery with charger  
Lithium-Batterie mit Ladegerät

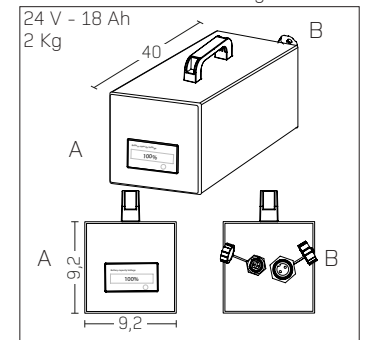

		art. B28 + art. B33		LEDs 2700-6500K		cover with zip		base frame kg 40 127x85x28 h cm		plate kg 22 50x50x3,5 cm	
		A	C1	C2	C3	4 bars	7 bars				
Ø 350 cm	8	art. P358						(260 cm)			12 x
250x250 cm	8	art. P25258						(220 cm)			12 x
300x300 cm	8	art. P30308						(260 cm)			12 x
350x350 cm	8	art. P35358						(300 cm)			12 x
300x400 cm	8	art. P30408						(300 cm)			12 x

22x48 mm - sp. 1,6 mm

	A	B	C1/2/3	D	E	F/G/H	I/L/M	N/O/P
Ø 350 cm	319 cm	325 cm	30 cm	238 cm	102 cm	440/350/90	-	-
250x250 cm	281 cm	294 cm	25 cm	224 cm	115 cm	-	340/250/90	-
300x300 cm	305 cm	316 cm	30 cm	240 cm	99 cm	-	390/300/90	-
350x350 cm	314 cm	323 cm	30 cm	239 cm	71 cm	-	440/350/90	-
300x400 cm	311 cm	320 cm	30 cm	240 cm	65 cm	-	-	390/400/90

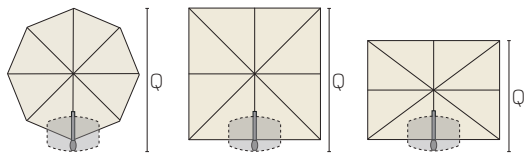

	Q
Ø 350 cm	381 cm
250x250 cm	281 cm
300x300 cm	331 cm
350x350 cm	381 cm
300x400 cm	331 cm

kg	umbrella	base frame	cement plates
kg. 40,00	40x340x68 h cm	132x90x35 h cm	100x120x35 h cm
kg. 38,00	40x340x68 h cm	132x90x35 h cm	100x120x35 h cm
kg. 40,00	40x340x68 h cm	132x90x35 h cm	100x120x35 h cm
kg. 43,00	40x340x68 h cm	132x90x35 h cm	100x120x35 h cm
kg. 45,00	40x340x68 h cm	132x90x35 h cm	100x120x35 h cm

telaio  
frame  
Gestell



rotazione 360°  
360 degree rotation  
360° drehbar



Ø 90x150 mm - sp. 3 mm (1)  
Ø 40x80 mm - sp. 2,5 mm (2)  
gas spring (3)

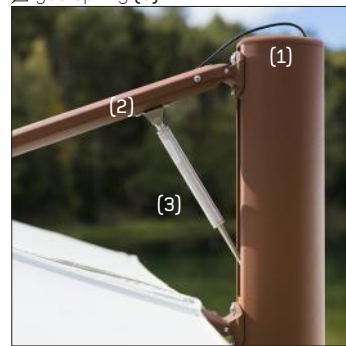

fissaggio telo  
canvas fixing system  
Befestigung von Sonnenschirmbezug



cerniera  
hinge  
Scharnier



barre integrate LED bianco dinamico  
integrated dynamic white LED bars  
integrierte LED-Leisten mit dimmbarem Weiß



maniglia  
handle  
Hebel



telaio base  
base frame  
Standrahmen



telaio base  
base frame  
Standrahmen

vano portaoggetti con coperchio  
storage box with lid  
Objektträger-Box mit Deckel  
12x40x23 h cm

cuscini per base  
seat cushions for base  
Sitzkissen für Standrahmen  
55x44x8 h cm

copri base  
base cover  
Standrahmen-Deckung

zavorre in cemento  
cement plates  
Betonplatten

telaio base  
base frame  
Standrahmen

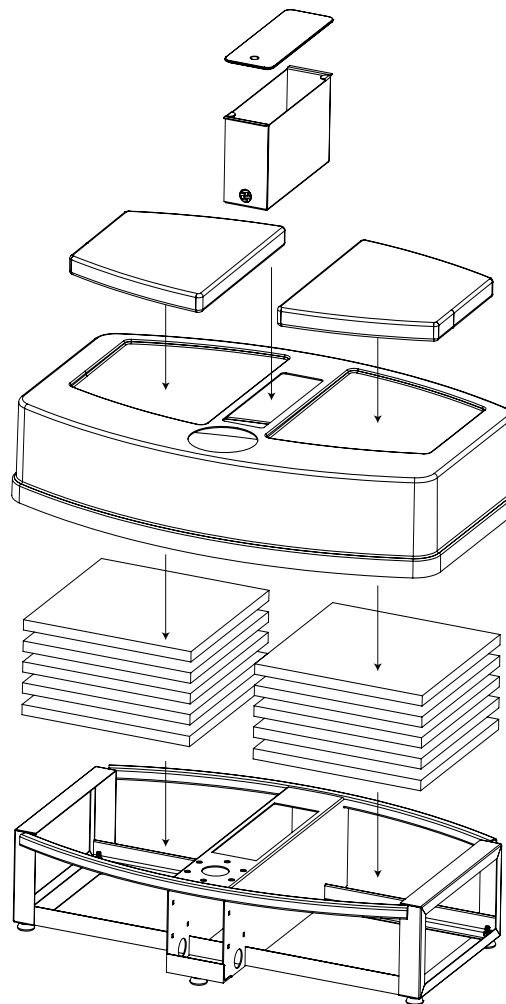

IT

Per aprire l'ombrellone Pan è necessario tenere premuta la maniglia verso il basso (1) e spingere l'hub verso l'esterno (2). Concludere l'apertura spingendo la maniglia verso l'alto fino a fine corsa (3).

Afferrando la maniglia e tirandola verso il basso, l'ombrellone si chiude in un unico movimento avvicinandosi al palo laterale lasciando libera l'area sottostante senza dover spostare tavoli e sedie.

EN

The Pan parasol opens by holding the handle (1) down and pushing the hub outwards (2). Concluding the opening by lifting the handle upwards as far as it will go (3).

The parasol closes in a single movement by grasping the handle and pulling it downwards. In this way it comes to the side pole leaving the area below free without moving tables and chairs.

DE

Um den Sonnenschirm Pan zu öffnen, halten Sie den Griff unten (1) und die Nabe nach außen (2). Schließen Sie die Öffnung ab, indem Sie den Griff bis zum Ende nach oben drücken (3).

Der Sonnenschirm schließt sich in einer einzigen Bewegung durch einen Griff an seinem Mast und lässt den Platz darunter frei, ohne Tische und Stühle entfernen zu müssen.

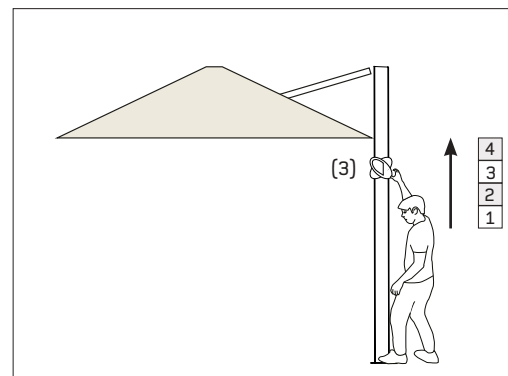
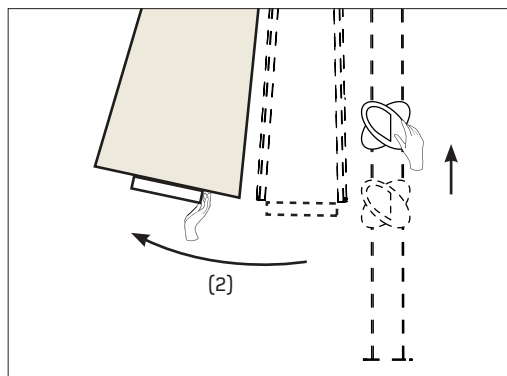
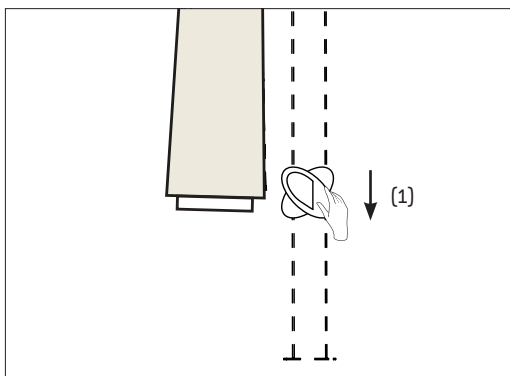

# MAXI

campioni di tessuti, bordi e verniciatura telai  
samples of fabrics, borders and varnished frames  
Muster von Stoffe, Säume und lackierte Gestellen

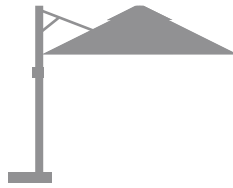

PAN

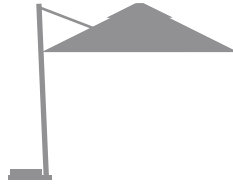

DIOMEDE



ADONE

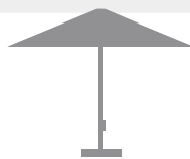

ADONE EVO



MINOSSE

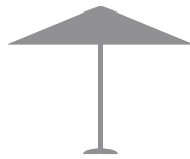

ELIO



EFESTO

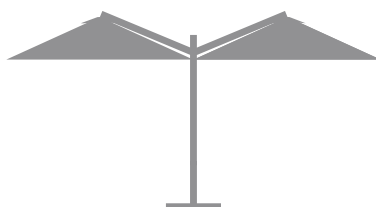

OLIMPO

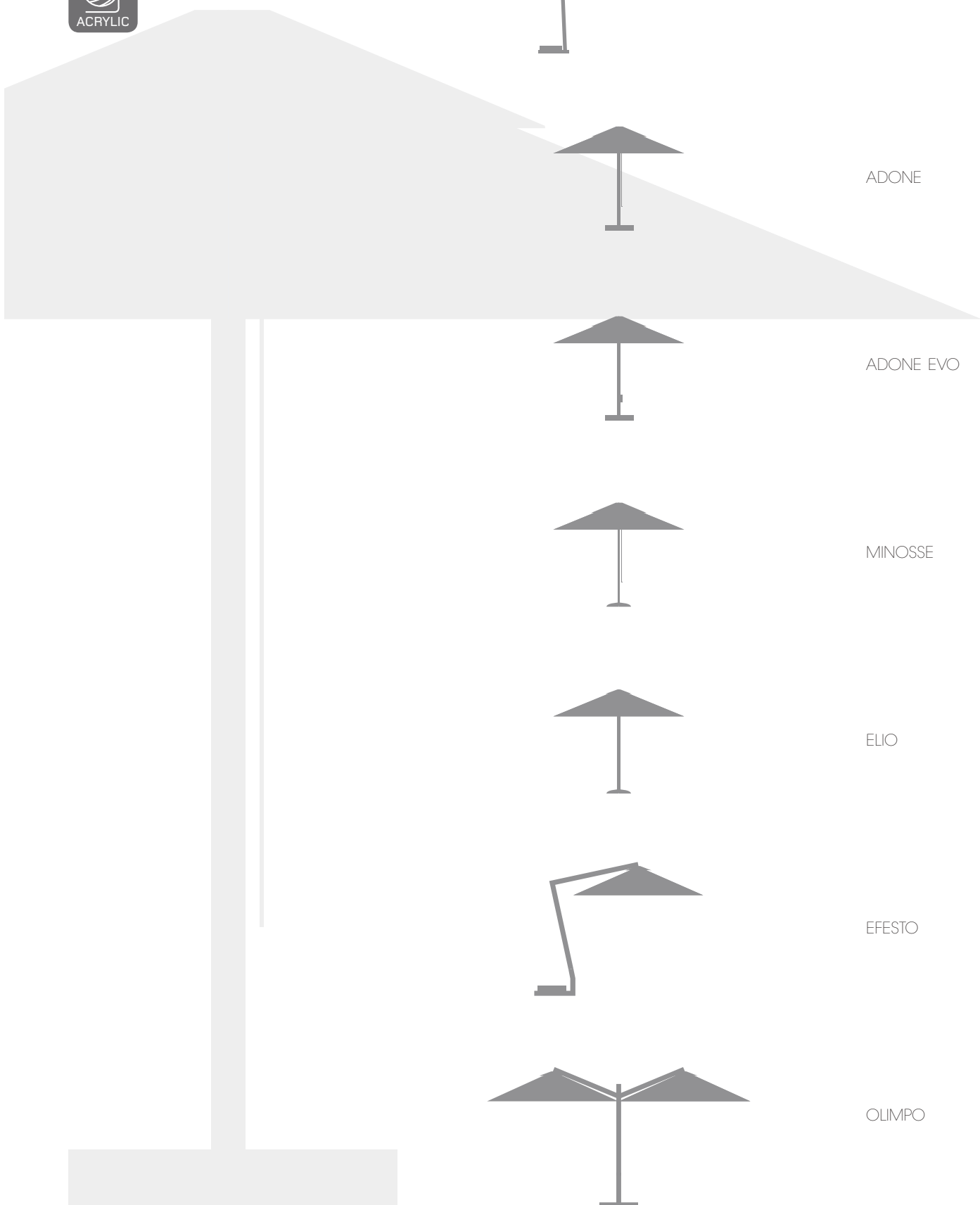

campioni di tessuti  
samples of fabrics  
Stoffe Muster



0001

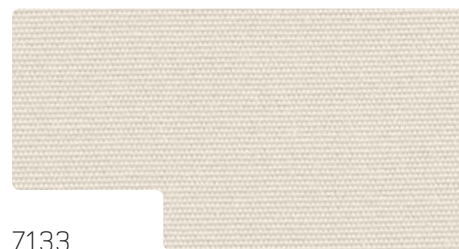

7133



7548



0681

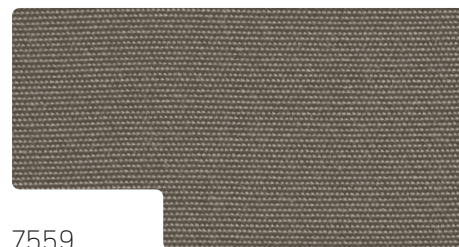

7559



U224



6196

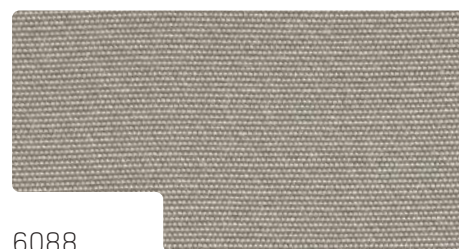

6088

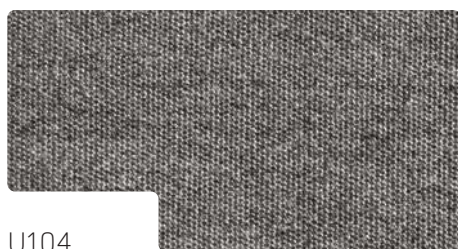

U104



U171



6028



jacquard fabric leaves  
price on request



87



7264



6022

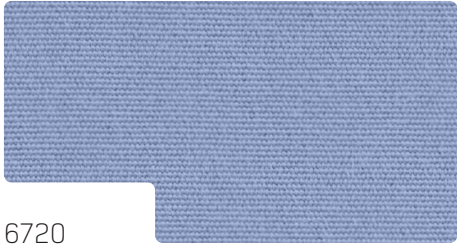

6720

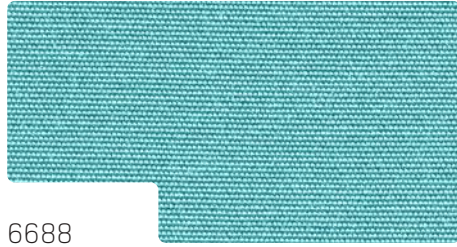

6688

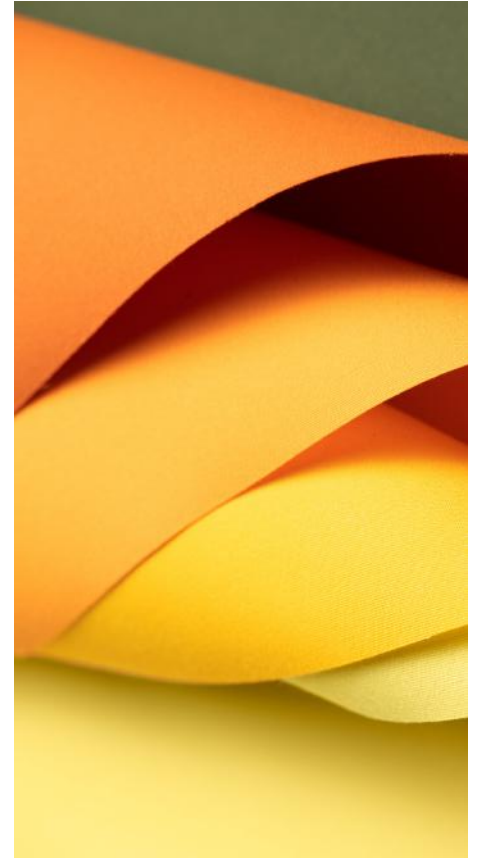

7244



0853



6687



6023

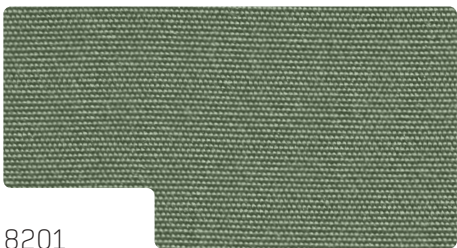

8201



7703



6316



0867



8777



8206



0020



3914

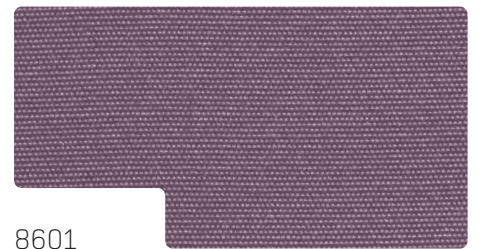

8601

# ADONE PLUS

Recycled PET solution dyed "outdoor"  
width 120 cm  
weight 290 g/m<sup>2</sup>  
water column ≥ 380 mm

n. 328 x  = 21 m<sup>2</sup> of fabric

price on request

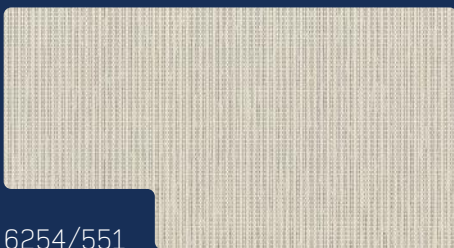

6254/551



6231/597

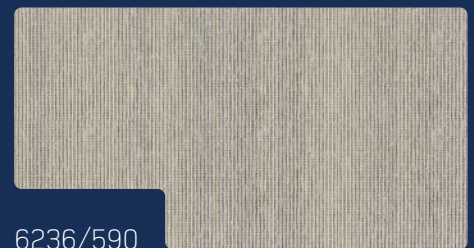

6236/590

campioni di tessuti  
samples of fabrics  
Muster von Stoffe



6015/100



6015/101

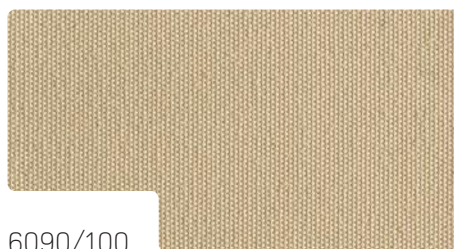

6090/100



6052/100



6079/100

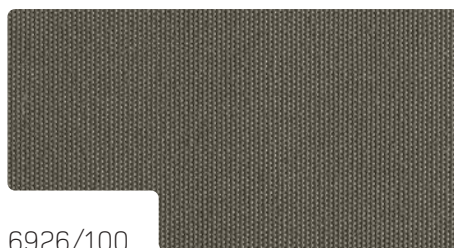

6926/100

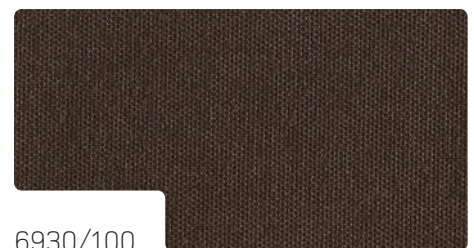

6930/100



6008/100

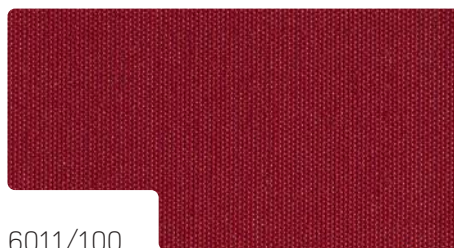

6011/100

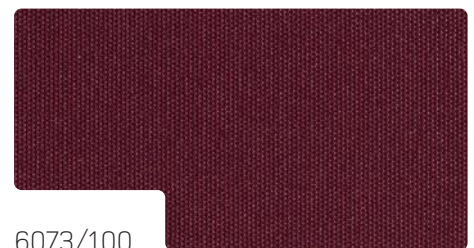

6073/100



BIANCO white lacquered



ANTRACITE anthracite lacquered



optional RAL  
not available for mod. elio

campioni di bordi | samples of borders | Säume Muster



15

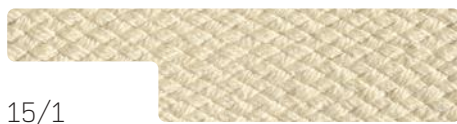

15/1

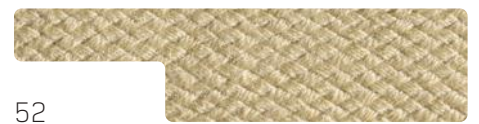

52



926



81



24



79

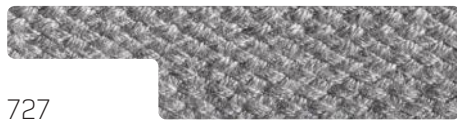

727



94

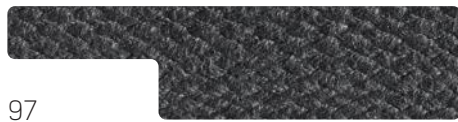

97

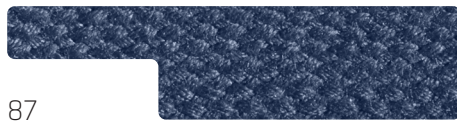

87

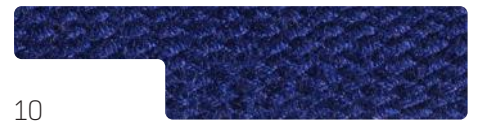

10



75

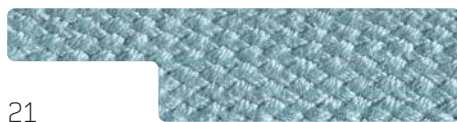

21



71



82/100



16



62

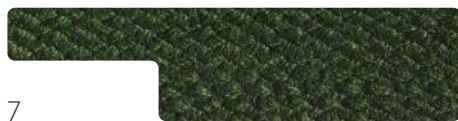

7



5



12



55



54



73



56



11

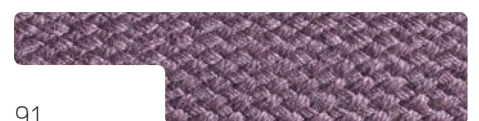

91



# TECHNICAL DATA - MAXI



<b>Composizione</b> Fibre analysis	100% fibra acrilica tinta in massa 100% Solution dyed acrylic fabric	100% fibra poliestere tinta in massa 100% Solution dyed polyester fabric
<b>Costruzione</b> Construction	ordito 29 fili/cm - trama 16 fili/cm warp 29 threads/cm - weft 16 threads/cm	ordito 28 fili/cm - trama 17 fili/cm warp 28 threads/cm - weft 17 threads/cm
<b>Titolo</b> Yarn number	ordito mN 2/34 - trama mN 2/34 warp mN 2/34 - weft mN 2/34	-
<b>Altezza</b> Width	120/183/200 cm 120/183/200 cm	120 cm 120 cm
<b>Peso</b> Weight	290 g/m <sup>2</sup> 290 g/m <sup>2</sup>	300 g/m <sup>2</sup> 300 g/m <sup>2</sup>
<b>Spessore</b> Thickness	0,64 mm 0,64 mm	0,44 mm 0,44 mm
<b>Resistenza alla trazione (UNI EN ISO 13934-1:2013)</b> Breaking load (UNI EN ISO 13934-1:2013)	ordito 1250 mN - trama 880 mN warp 1250 mN - weft 880 mN	ordito 2100 mN - trama 1400 mN warp 2100 mN - weft 1400 mN
<b>Finissaggio (trattamento Cleangard)</b> Finishing (Cleangard treatment)	idro-oleorepellente e repulsione allo sporco water, oil and dirt repellent	idro-oleorepellente e repulsione allo sporco water, oil and dirt repellent
<b>Xenotest 1000 h (UNI EN ISO 105-B04:2000)</b> Xenotest 1000 h (UNI EN ISO 105-B04:2000)	4 class/5 4 class/5	-
<b>Colonna d'acqua (UNI EN ISO 811/2018)</b> Water column (UNI EN ISO 811/2018)	350/370 mm 350/370 mm	≥ 380 mm ≥ 380 mm
<b>Impermeabilità (UNI EN ISO 4920:2013)</b> Impermeability (UNI EN ISO 4920:2013)	Spray Test 5 (100) Spray Test 5 (100)	Spray Test 5 (100) Spray Test 5 (100)
<b>Resistenza all'abrasione (UNI EN ISO 5470-2:2004)</b> Rubber test (UNI EN ISO 5470-2:2004)	> 20.000 cicli > 20.000 cycles	> 20.000 cicli > 20.000 cycles
<b>Resistenza alla luce (UNI EN ISO 105-B02:2014)</b> Colour fastness to light (UNI EN ISO 105-B02:2014)	7/8 scala dei blu - 4/5 scala dei grigi 7/8 degree blu scale - 4/5 degree grey scale	7/8 scala dei blu - 4/5 scala dei grigi 7/8 degree blu scale - 4/5 degree grey scale
<b>Resistenza alle intemperie (UNI EN ISO 105-B04:2000)</b> Colour fastness to weather condition (UNI EN ISO 105-B04:2000)	7/8 scala dei blu - 4/5 scala dei grigi 7/8 degree blu scale - 4/5 degree grey scale	7/8 scala dei blu - 4/5 scala dei grigi 7/8 degree blu scale - 4/5 degree grey scale



don't iron



don't bleach



dry cleaning is not allowed



only cold washing is permitted



cold hand washing is permitted



don't use pressure-washer



**FINISHING  
CLEANGARD®  
OUTDOOR TREATMENT**