



ADONE PLUS

ombrellone gigante telescopico | telescopic giant parasol
riesengroßer Teleskop-Sonnenschirm

IT

- struttura telescopica in alluminio verniciato
- componenti in acciaio verniciato
- bulloneria in acciaio inox
- stecche in alluminio verniciato
- apertura telescopica con due aste e maniglie tensionatrici
- tessuto in poliestere e bordo in acrilico tinto in massa
- camino antivento con telaio in alluminio

DE

- Teleskop-Gestell aus lackiertem Aluminium
- lackierte Stahlbestandteile
- Edelstahlbolzen
- Streben aus lackiertem Aluminium
- Teleskopöffnung mit zwei Teleskopstangen und Spannhebel
- Stoff aus Polyester und Saum aus düsengefärbter Acrylfaser
- Windkamin mit Alu-Struktur

EN

- telescopic pole of varnished aluminium
- varnished steel components
- nuts and bolts of stainless steel
- ribs of varnished aluminium
- telescopic opening with two poles and handles
- polyester fabric and acrylic border
- wind-proof chimney with aluminium frame



bases



details



accessories



location



colours

telaio nei colori bianco, antracite o RAL a scelta
frame available in white, anthracite or optional RAL
Gestellfarben: Weiß, Antrazit oder RAL-Farben nach Wahl



sistema telescopico di apertura e chiusura
telescopic opening and closing system
Teleskopöffnung-Schließung System

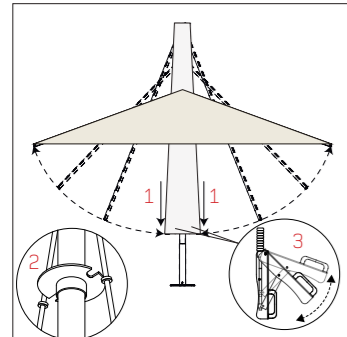

radiocomando illuminazione a LED
remote control for lighting LED
Fernbedienung für LED-Beleuchtung



cerniera di fissaggio
fixing hinge
Stellscharnier zu befestigen



stecche rinforzate con profilo interno
stronger ribs with internal profile
verstärkte Streben mit innerem Profil

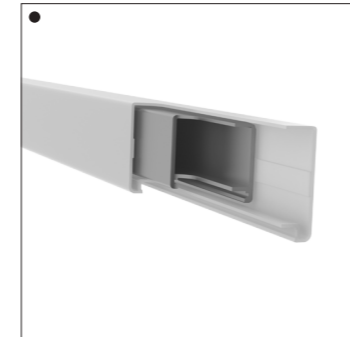

						art. B21 + art. B31	art. B55	art. B56
				2700-6500K	cover with zip	base kg 42 107x107x19 h cm	plate kg 42 50x50x7 h cm	underground base
				4 bars	full bars			base to be fixed 45x45x1 h cm
Ø 700 cm	12	art. AP7012				(410 cm)	8 x	
Ø 750 cm	12	art. AP7512				(440 cm)	8 x	
Ø 800 cm	12	art. AP8012				(450 cm)	8 x	
500x500 cm	12	art. AP505012				(400 cm)	8 x	
550x550 cm	12	art. AP555512				(440 cm)	8 x	
600x600 cm	12	art. AP606012				(480 cm)	8 x	
650x650 cm	12	art. AP656512				(520 cm)	8 x	
700x700 cm	12	art. AP707012				(550 cm)	*12 x	
400x600 cm	10	art. AP406010				(410 cm)	8 x	
500x550 cm	12	art. AP505512				(440 cm)	8 x	
500x600 cm	10	art. AP506010				(450 cm)	8 x	
500x700 cm	10	art. AP507010				(490 cm)	8 x	
550x650 cm	12	art. AP556512				(480 cm)	8 x	
600x700 cm	12	art. AP607012				(520 cm)	*12 x	

27x47 mm - sp. 1,40 mm

* for 700x700 cm only: 8x 50x50x7 h cm (kg 42) + 4x 50x50x10 h cm (kg 60)

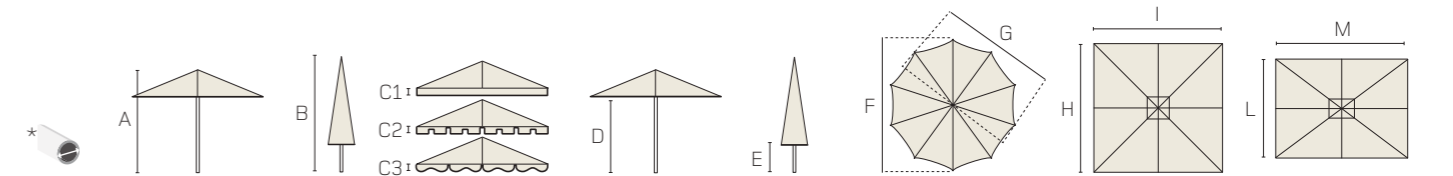

		A	B	C1/2/3	D	E	F/G	H/I	L/M
• Ø 700 cm	100 mm	343 cm	467 cm	35 cm	224 cm	108 cm	700/677 cm	-	-
• Ø 750 cm	130 mm	357 cm	482 cm	35 cm	230 cm	96 cm	750/723 cm	-	-
• Ø 800 cm	130 mm	344 cm	458 cm	35 cm	241 cm	54 cm	800/773 cm	-	-
500x500 cm	100 mm	329 cm	443 cm	35 cm	234 cm	87 cm	-	500/500 cm	-
550x550 cm	100 mm	349 cm	463 cm	35 cm	246 cm	70 cm	-	550/550 cm	-
600x600 cm	100 mm	347 cm	498 cm	35 cm	240 cm	69 cm	-	600/600 cm	-
• 650x650 cm	130 mm	382 cm	500 cm	35 cm	264 cm	34 cm	-	650/650 cm	-
• 700x700 cm	130 mm	399 cm	528 cm	35 cm	275 cm	26 cm	-	700/700 cm	-
400x600 cm	100 mm	331 cm	438 cm	35 cm	236 cm	76 cm	-	-	400/600 cm
500x550 cm	100 mm	332 cm	445 cm	35 cm	230 cm	69 cm	-	-	500/550 cm
500x600 cm	100 mm	346 cm	465 cm	35 cm	236 cm	69 cm	-	-	500/600 cm
• 500x700 cm	100 mm	356 cm	474 cm	35 cm	240 cm	39 cm	-	-	500/700 cm
• 550x650 cm	100 mm	345 cm	460 cm	35 cm	231 cm	29 cm	-	-	550/650 cm
• 600x700 cm	130 mm	401 cm	511 cm	35 cm	267 cm	40 cm	-	-	600/700 cm

* Ø pole 100 mm - sp. 3 mm / Ø pole 130 mm - sp. 4 mm

	kg	umbrella	base joint	umbrella + heater system	base frame	cement plates
Ø 700 cm	kg. 83,00	45x401x52 h cm	32x32x102 h cm	45x500x52 h cm	113x113x22 h cm	100x120x40 h cm
Ø 750 cm	kg. 91,00	45x500x52 h cm	-	45x500x52 h cm	113x113x22 h cm	100x120x40 h cm
Ø 800 cm	kg. 99,00	45x500x52 h cm	-	45x500x52 h cm	113x113x22 h cm	100x120x40 h cm
500x500 cm	kg. 86,00	45x400x52 h cm	32x32x102 h cm	45x500x52 h cm	113x113x22 h cm	100x120x40 h cm
550x550 cm	kg. 86,00	45x400x52 h cm	32x32x102 h cm	45x500x52 h cm	113x113x22 h cm	100x120x40 h cm
600x600 cm	kg. 90,00	45x433x52 h cm	32x32x102 h cm	45x540x52 h cm	113x113x22 h cm	100x120x40 h cm
650x650 cm	kg. 97,00	45x540x52 h cm	-	45x540x52 h cm	113x113x22 h cm	100x120x40 h cm
700x700 cm	kg. 100,00	45x540x52 h cm	-	45x540x52 h cm	113x113x22 h cm	100x120x50 h cm
400x600 cm	kg. 70,00	45x400x52 h cm	32x32x102 h cm	45x500x52 h cm	113x113x22 h cm	100x120x40 h cm
500x550 cm	kg. 66,00	45x400x52 h cm	32x32x102 h cm	45x500x52 h cm	113x113x22 h cm	100x120x40 h cm
500x600 cm	kg. 76,00	45x412x52 h cm	32x32x102 h cm	45x540x52 h cm	113x113x22 h cm	100x120x40 h cm
500x700 cm	kg. 85,00	45x440x52 h cm	32x32x102 h cm	45x540x52 h cm	113x113x22 h cm	100x120x40 h cm
550x650 cm	kg. 95,00	45x436x52 h cm	32x32x102 h cm	45x540x52 h cm	113x113x22 h cm	100x120x40 h cm
600x700 cm	kg. 99,00	45x540x52 h cm	-	45x540x52 h cm	113x113x22 h cm	100x120x40 h cm

MAXI

campioni di tessuti, bordi e verniciatura telai
samples of fabrics, borders and varnished frames
Muster von Stoffe, Säume und lackierte Gestellen

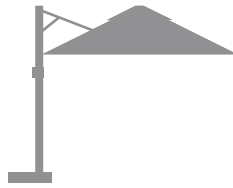

PAN

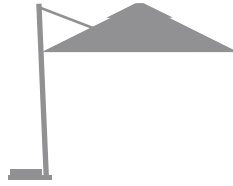

DIOMEDE



ADONE

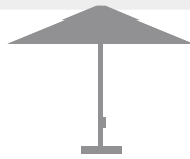

ADONE EVO



MINOSSE

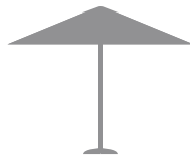

ELIO

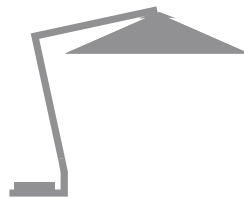

EFESTO

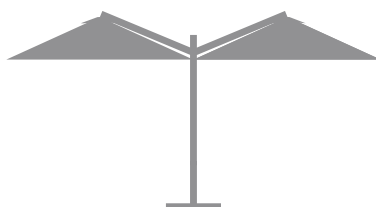

OLIMPO

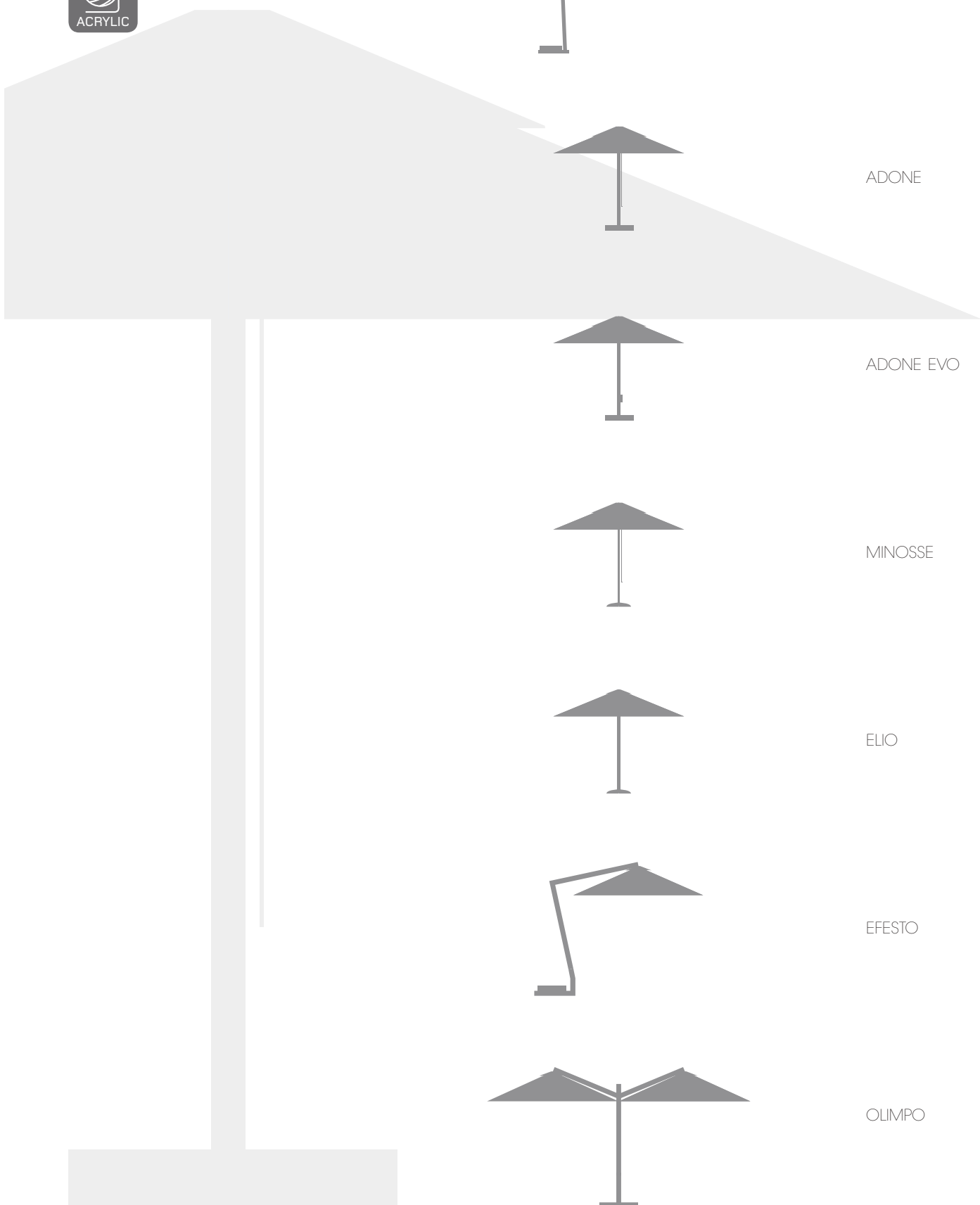

campioni di tessuti
samples of fabrics
Stoffe Muster



0001

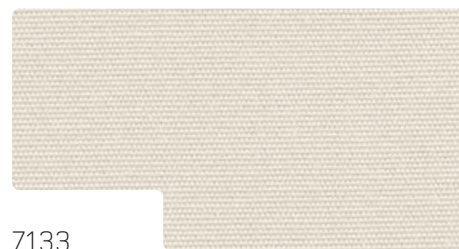

7133

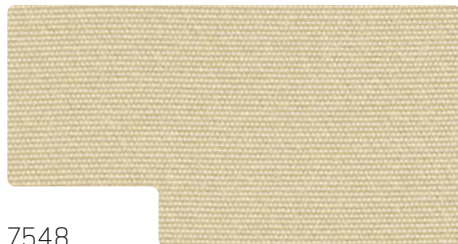

7548

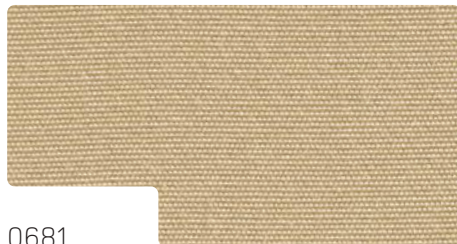

0681

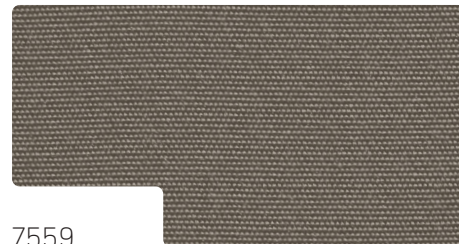

7559



U224



6196

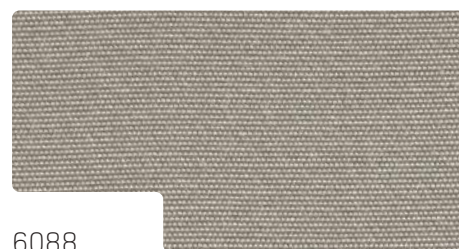

6088

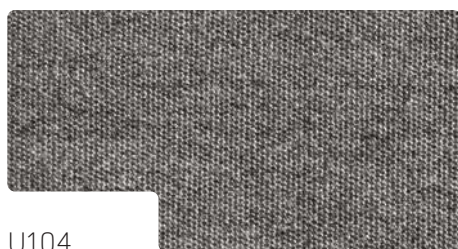

U104



U171



6028



jacquard fabric leaves
price on request



87



7264



6022

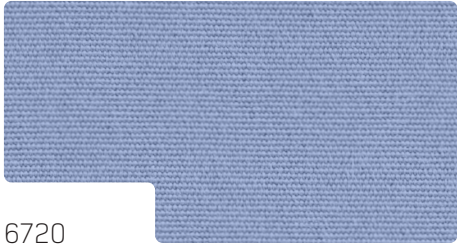

6720

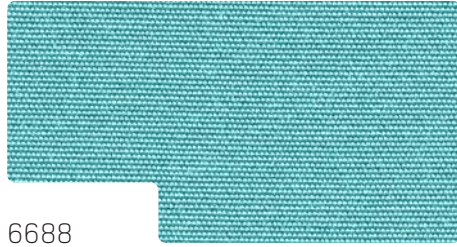

6688

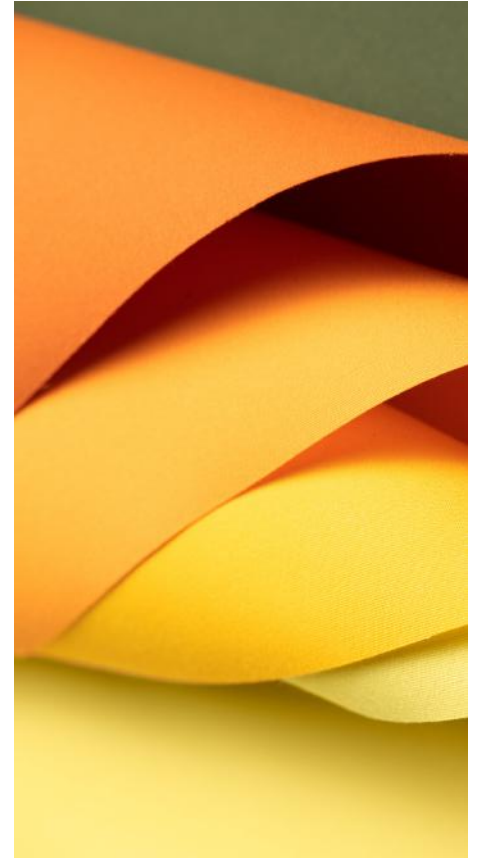

7244



0853



6687



6023

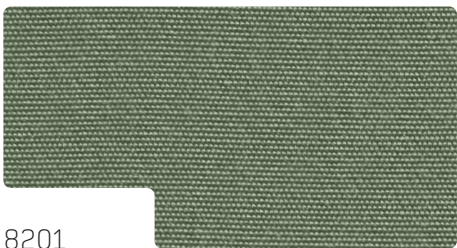

8201



7703



6316



0867



8777



8206



0020



3914

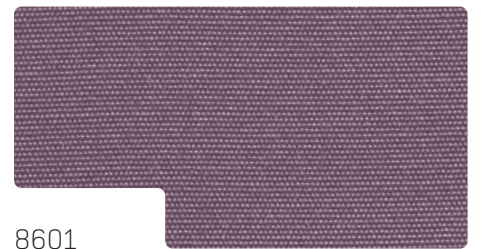

8601

ADONE PLUS

Recycled PET solution dyed "outdoor"
width 120 cm
weight 290 g/m²
water column ≥ 380 mm

n. 328 x  = 21 m² of fabric

price on request

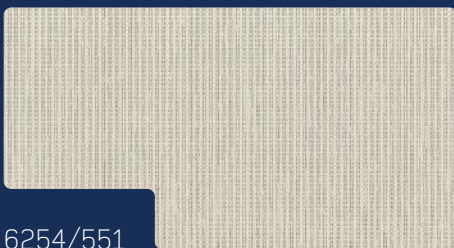

6254/551



6231/597

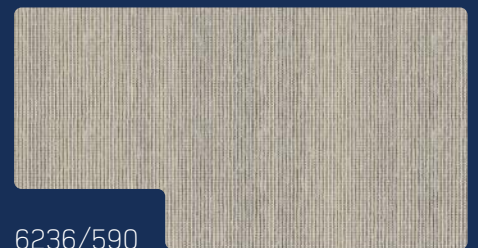

6236/590

campioni di tessuti
samples of fabrics
Muster von Stoffe



6015/100

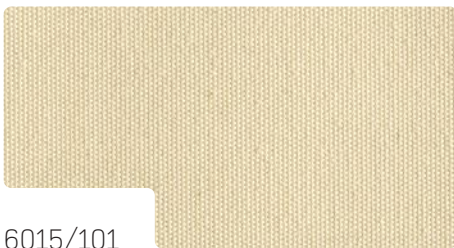

6015/101

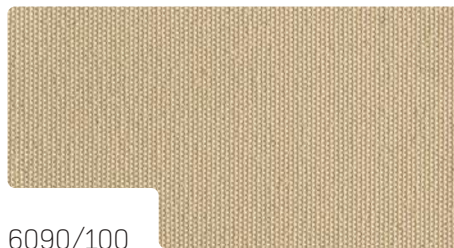

6090/100

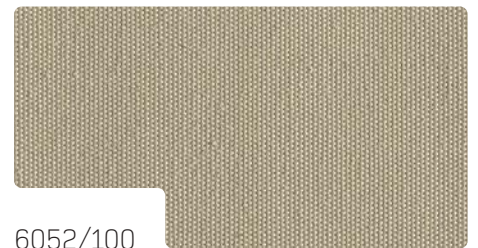

6052/100



6079/100

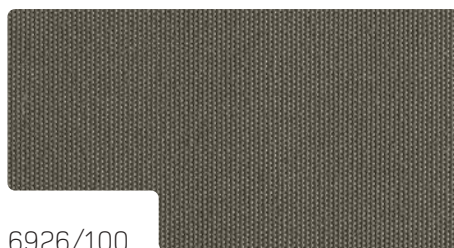

6926/100

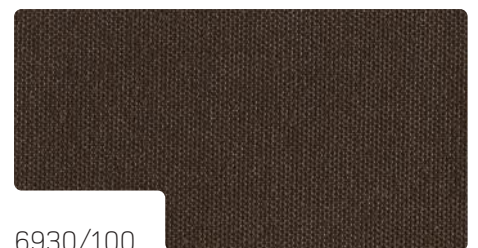

6930/100



6008/100

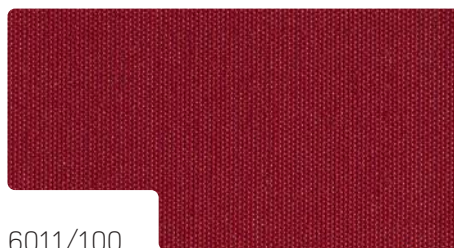

6011/100

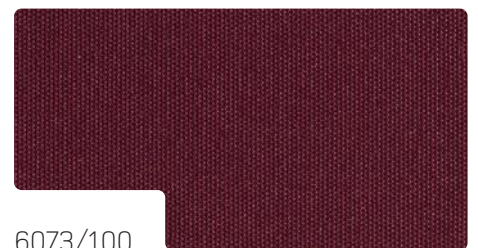

6073/100



BIANCO white lacquered



ANTRACITE anthracite lacquered



optional RAL
not available for mod. elio

campioni di bordi | samples of borders | Säume Muster



15

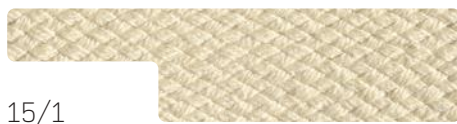

15/1

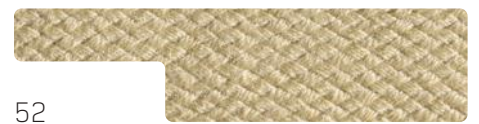

52



926



81



24



79

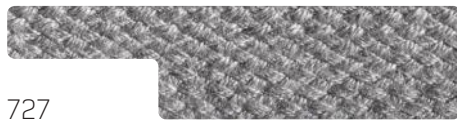

727



94

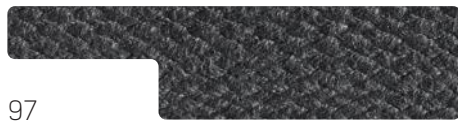

97

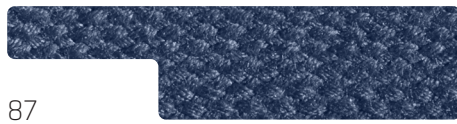

87

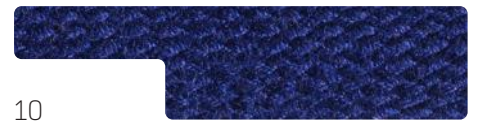

10



75

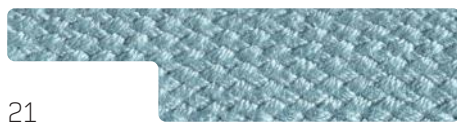

21



71

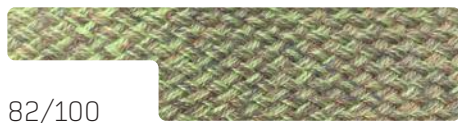

82/100



16



62

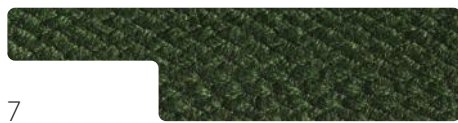

7



5



12



55



54



73



56



11

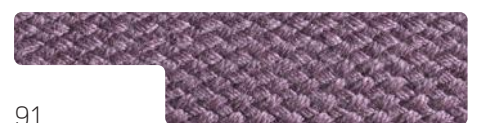

91

TECHNICAL DATA - MAXI



Composizione Fibre analysis	100% fibra acrilica tinta in massa 100% Solution dyed acrylic fabric	100% fibra poliestere tinta in massa 100% Solution dyed polyester fabric
Costruzione Construction	ordito 29 fili/cm - trama 16 fili/cm warp 29 threads/cm - weft 16 threads/cm	ordito 28 fili/cm - trama 17 fili/cm warp 28 threads/cm - weft 17 threads/cm
Titolo Yarn number	ordito mN 2/34 - trama mN 2/34 warp mN 2/34 - weft mN 2/34	-
Altezza Width	120/183/200 cm 120/183/200 cm	120 cm 120 cm
Peso Weight	290 g/m ² 290 g/m ²	300 g/m ² 300 g/m ²
Spessore Thickness	0,64 mm 0,64 mm	0,44 mm 0,44 mm
Resistenza alla trazione (UNI EN ISO 13934-1:2013) Breaking load (UNI EN ISO 13934-1:2013)	ordito 1250 mN - trama 880 mN warp 1250 mN - weft 880 mN	ordito 2100 mN - trama 1400 mN warp 2100 mN - weft 1400 mN
Finissaggio (trattamento Cleangard) Finishing (Cleangard treatment)	idro-oleorepellente e repulsione allo sporco water, oil and dirt repellent	idro-oleorepellente e repulsione allo sporco water, oil and dirt repellent
Xenotest 1000 h (UNI EN ISO 105-B04:2000) Xenotest 1000 h (UNI EN ISO 105-B04:2000)	4 class/5 4 class/5	-
Colonna d'acqua (UNI EN ISO 811/2018) Water column (UNI EN ISO 811/2018)	350/370 mm 350/370 mm	≥ 380 mm ≥ 380 mm
Impermeabilità (UNI EN ISO 4920:2013) Impermeability (UNI EN ISO 4920:2013)	Spray Test 5 (100) Spray Test 5 (100)	Spray Test 5 (100) Spray Test 5 (100)
Resistenza all'abrasione (UNI EN ISO 5470-2:2004) Rubber test (UNI EN ISO 5470-2:2004)	> 20.000 cicli > 20.000 cycles	> 20.000 cicli > 20.000 cycles
Resistenza alla luce (UNI EN ISO 105-B02:2014) Colour fastness to light (UNI EN ISO 105-B02:2014)	7/8 scala dei blu - 4/5 scala dei grigi 7/8 degree blu scale - 4/5 degree grey scale	7/8 scala dei blu - 4/5 scala dei grigi 7/8 degree blu scale - 4/5 degree grey scale
Resistenza alle intemperie (UNI EN ISO 105-B04:2000) Colour fastness to weather condition (UNI EN ISO 105-B04:2000)	7/8 scala dei blu - 4/5 scala dei grigi 7/8 degree blu scale - 4/5 degree grey scale	7/8 scala dei blu - 4/5 scala dei grigi 7/8 degree blu scale - 4/5 degree grey scale



don't iron



don't bleach



dry cleaning is not allowed



only cold washing is permitted



cold hand washing is permitted



don't use pressure-washer



**FINISHING
CLEANGARD®
OUTDOOR TREATMENT**